

Fold on line

Fold on line

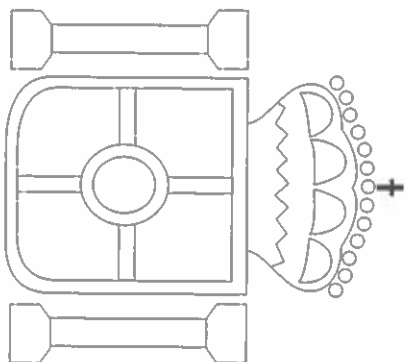

ESPAÑA

Fold on line

Fold on line

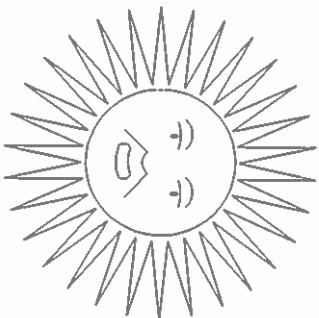

ARGENTINA

Fold on line

Fold on line

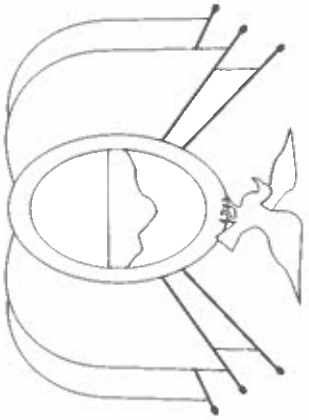

BOLIVIA

Fold on line

Fold on line

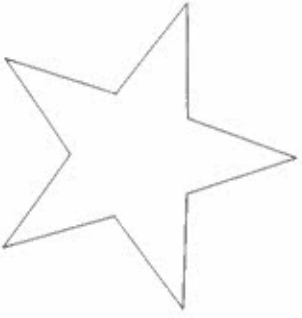

CHILE

Fold on line

Fold on line

--	--	--

COLOMBIA

Fold on line

Fold on line

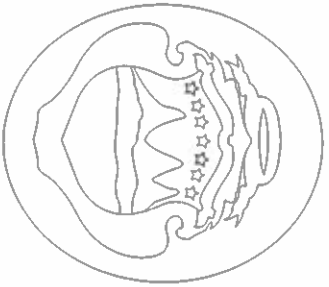

COSTA RICA

Fold on line

Fold on line

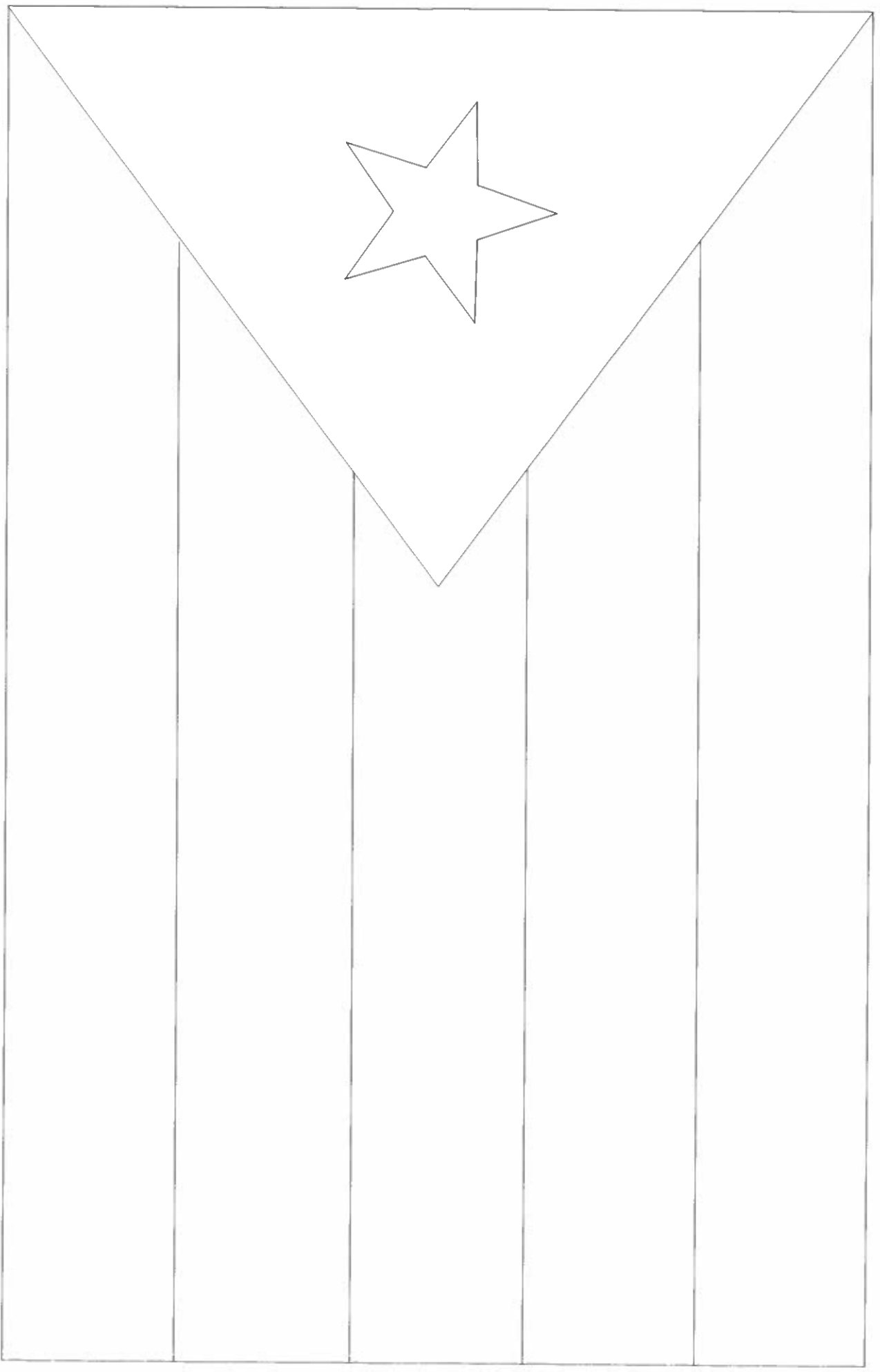

CUBA

Fold on line

Fold on line

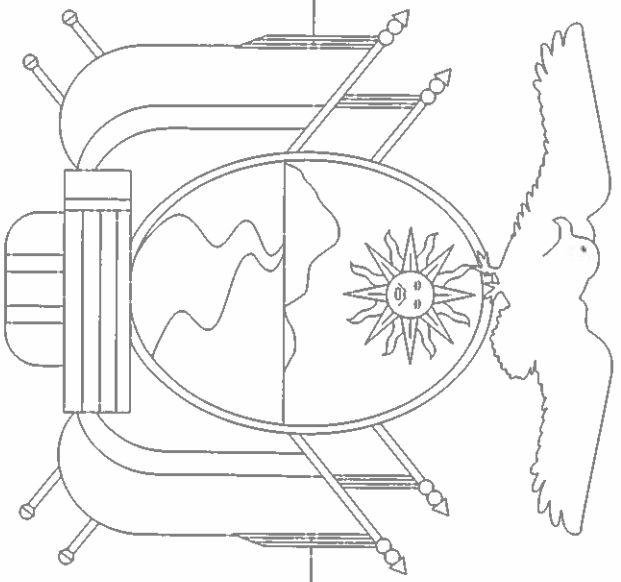

ECUADOR

Fold on line

Fold on line

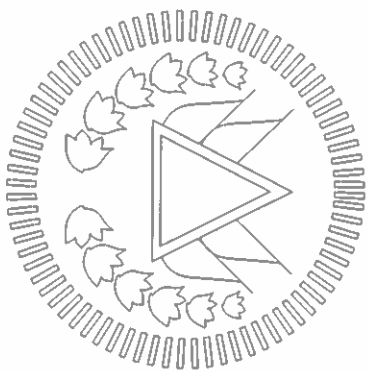

EL SALVADOR

Fold on line

Fold on line



GUATEMALA

©2001 by Language Adventure Publications

Fold on line

Fold on line



HONDURAS

Fold on line

Fold on line



MÉXICO

Fold on line

Fold on line

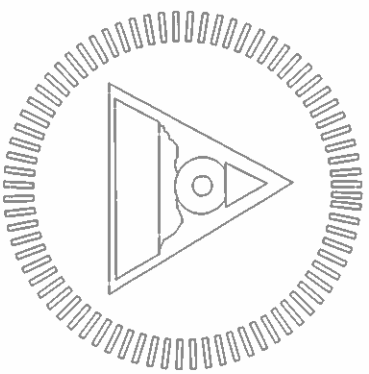

NICARAGUA

Fold on line

Fold on line

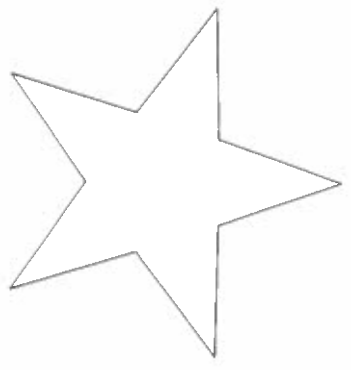
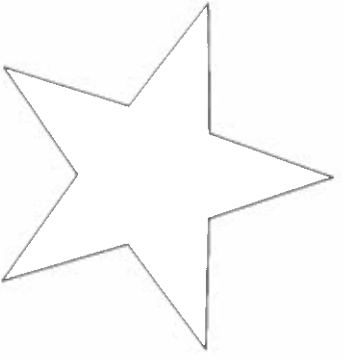

PANAMA

©2001 by Language Adventure Publications

Fold on line

Fold on line



PARAGUAY

Fold on line

Fold on line

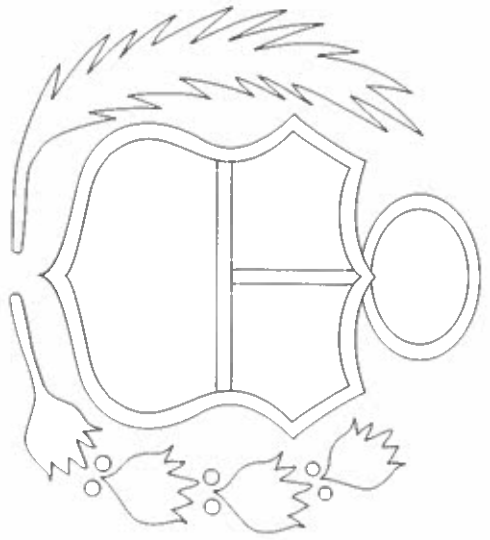

PERÚ

Fold on line

Fold on line

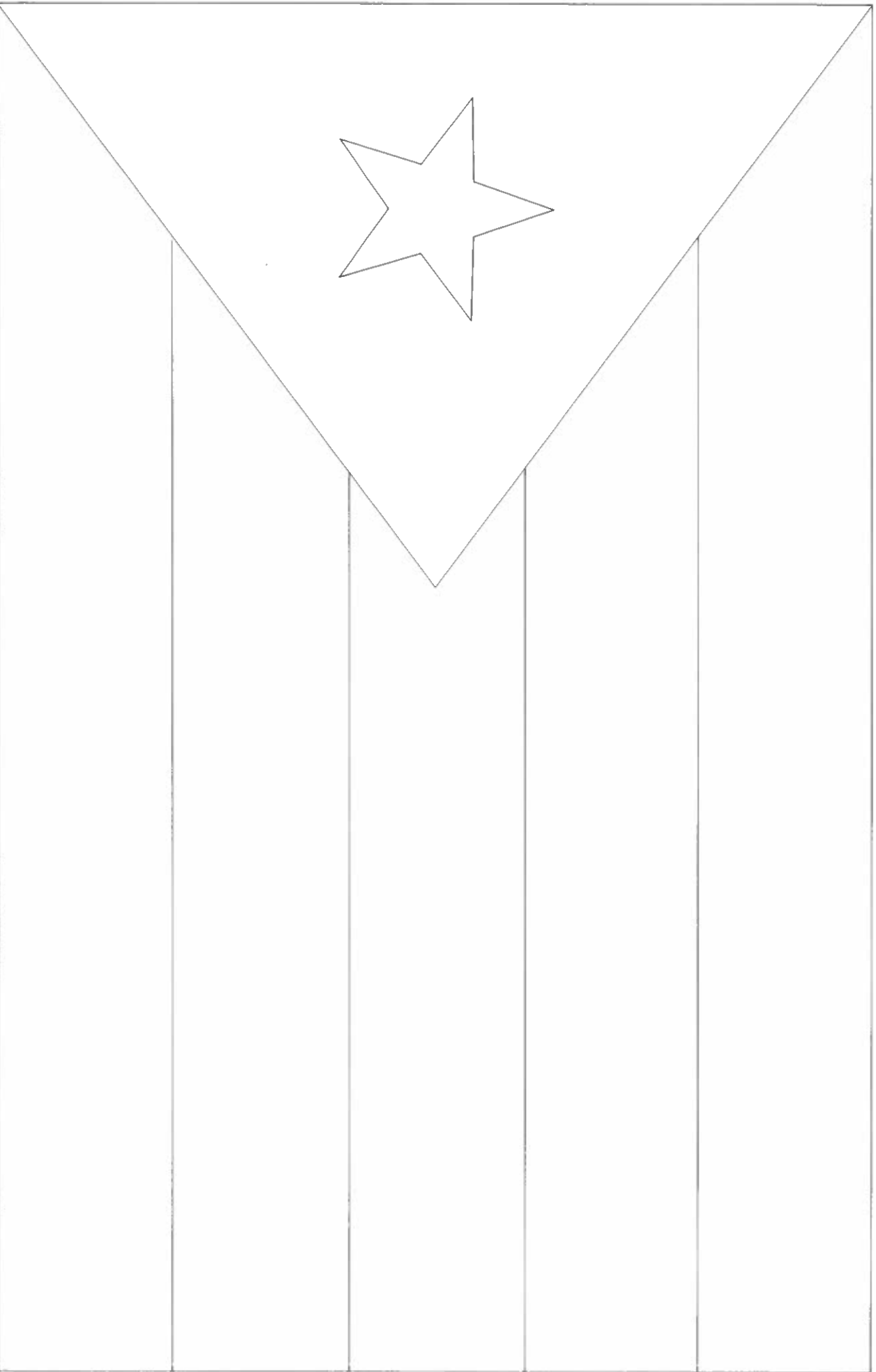

PUERTO RICO

Fold on line

Fold on line

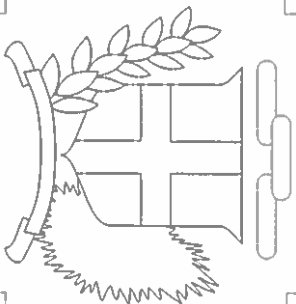

REPÚBLICA DOMINICANA

©2001 by Language Adventure Publications

Fold on line

Fold on line

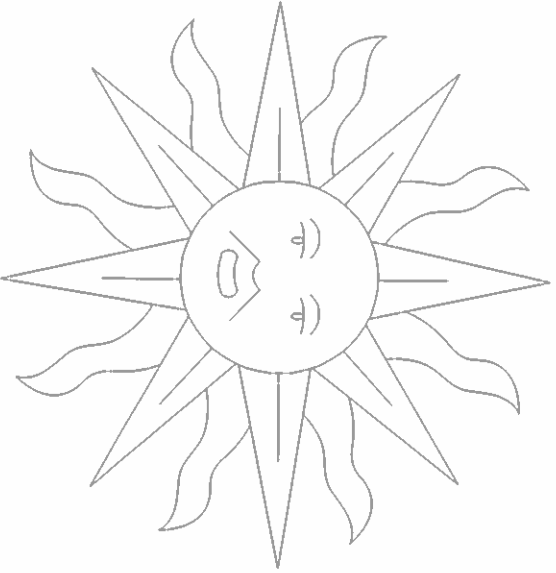

Two vertical rectangular boxes for writing.

URUGUAY

Fold on line

Fold on line



VENEZUELA